

A sleek, micro cylindrical LED spotlight system for showcase and cabinet display lighting.

Compact, magnetically mounted narrow beam luminaires for showcases and shelves. Easily repositioned, discreet in appearance, and expandable at any time to suit changing display needs.

For museums, hospitality, retail and residential showcase and shelf lighting applications.



1.2 WATT SPECIFICATIONS:

Lumens: 100 lm

CRI: 90+

Wattage: 1.2W

Beam Angles: 25° and 60°

Dimming: MLV/ELV Dimmers
(with dimmable driver)

Voltage: 12V DC

Rating: Dry Locations

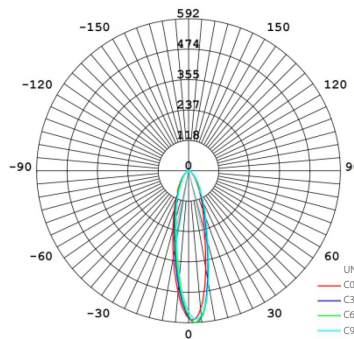

AVERAGE BEAM ANGLE (50%): 25.1 DEG

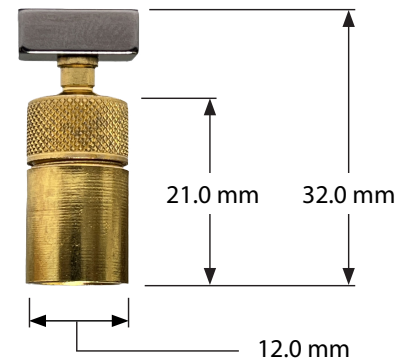

Order Code Example:

MSL 27K 60 1W PBK

Fixture Family	Colour Temperature	Beam Angle	Watts	Finish	CRI	Dimensions
MSL	27K = 2700K 30K = 3000K	25° 60°	1 = 1.2W 2 = 2W	GD = Gold PBK = Pewter Black	90+	12 mm diam (0.4724 in) x 32 mm long (1.2598 in)



2 WATT SPECIFICATIONS:

Lumens: 185 lm

CRI: 95+

Wattages: 2W

Beam Angles: 15° and 30°

Dimming: MLV/ELV Dimmers

(with dimmable driver)

Voltage: 12V DC

Rating: Dry Locations

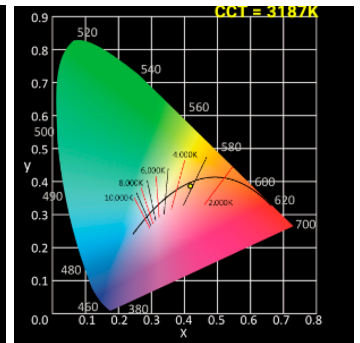
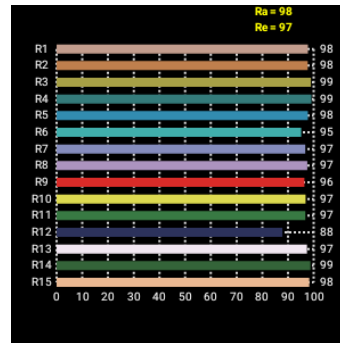
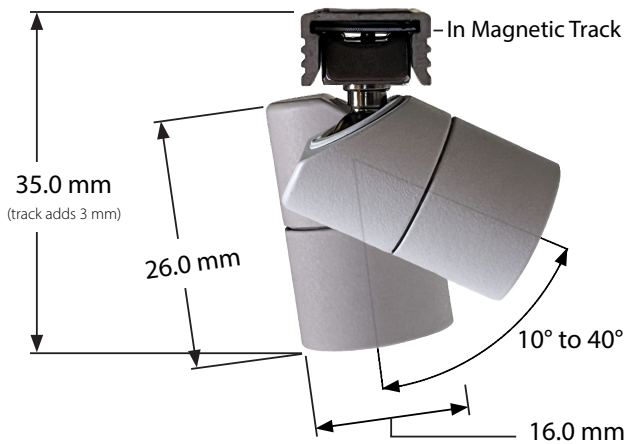

Order Code Example:

MSL 30K 30 2W BK

Fixture Family	Colour Temperature	Beam Angle	Watts	Finish	CRI	Dimensions
MSL	30K = 3000K	15° 30°	2 = 2W	W = White BK = Black	95+	16 mm diam (0.63 in) x 35 mm long (1.38 in)

12 Volt DC 1.2 / 2 Watt Micro Magnetic Showcase Track Lights

Magnetic Low Profile Track (2 m)

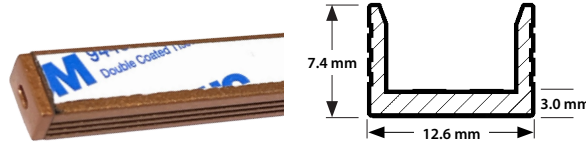
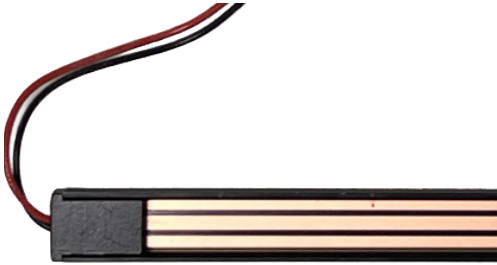

Dimensions:
Length:
2 m (78.74 in)
Width:
12.6 mm (0.49 in)
Height:
7.4 mm (0.29 in)

SKU	Finish	Wire
1747-MMT-BK	Black	255 cm (100 in)
1746-MMT-GD	Copper Gold	255 cm (100 in)

Magnetic Track Inline Connector

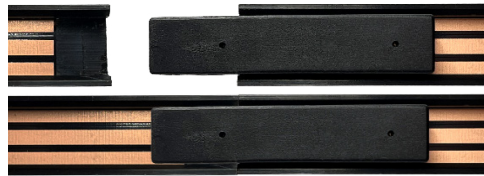

Dimensions:
Length:
2 m (78.74 in)
Width:
12.6 mm (0.49 in)
Height:
7.4 mm (0.29 in)

SKU	Finish	Wire
1832-MMT-Inl	Black	none

Magnetic Track Angle Connector



Dimensions:
Length:
2 m (78.74 in)
Width:
12.6 mm (0.49 in)
Height:
7.4 mm (0.29 in)

SKU	Finish	Wire
1833-MMT-L	White	3.5 cm (1.37 in)

Magnetic In-Track Power Connector



Dimensions:
Length:
2 m (78.74 in)
Width:
12.6 mm (0.49 in)
Height:
7.4 mm (0.29 in)

SKU	Finish	Wire
1834-MMTP	Black	28 cm (11 in)

Dimmable Power Supply



100V - 277V AC INPUT

DC OUTPUT



Screw Terminal Connections

Specifications:

Input Voltage: 110V to 277V AC.

Output Voltage: 12V DC

Output Power: 30W

Dimming: MLV, ELV

Dimming Range: 100% to 0.1%

Certifications: cUL, Class 2, Class P, FCC, NEMA 4X, RoHS

Title 24 and JA8 Compliant

Rated: For dry, and damp locations

Adjustable Output Voltage

SKU	Finish	Power
1780-ps-dim-12v30w	White	30w

Dimensions:

Length: 154.2 mm

Width: 54.0 mm

Height: 20.4 mm

Weight: 0.212 kg.
(0.467 lbs)

Non-Dimmable Plug-In Power Supply



Specifications:

Input Voltage: 100V - 240V AC.

Output Voltage: 12V DC

Output Power: 60W

Certifications: cUL, Class 2, Class P, FCC, NEMA 4X, RoHS

Title 24 and JA8 Compliant

Rated: For dry locations

SKU	Finish	Power
544 ps-12v60w	Black	60w

Dimensions:

Length: 93.5 mm

Width: 35.0 mm

Height: 51.5 mm

Cord: 1030 mm
(40.55 in)